

WINE LIBRARY

Beauty
at the service
of taste

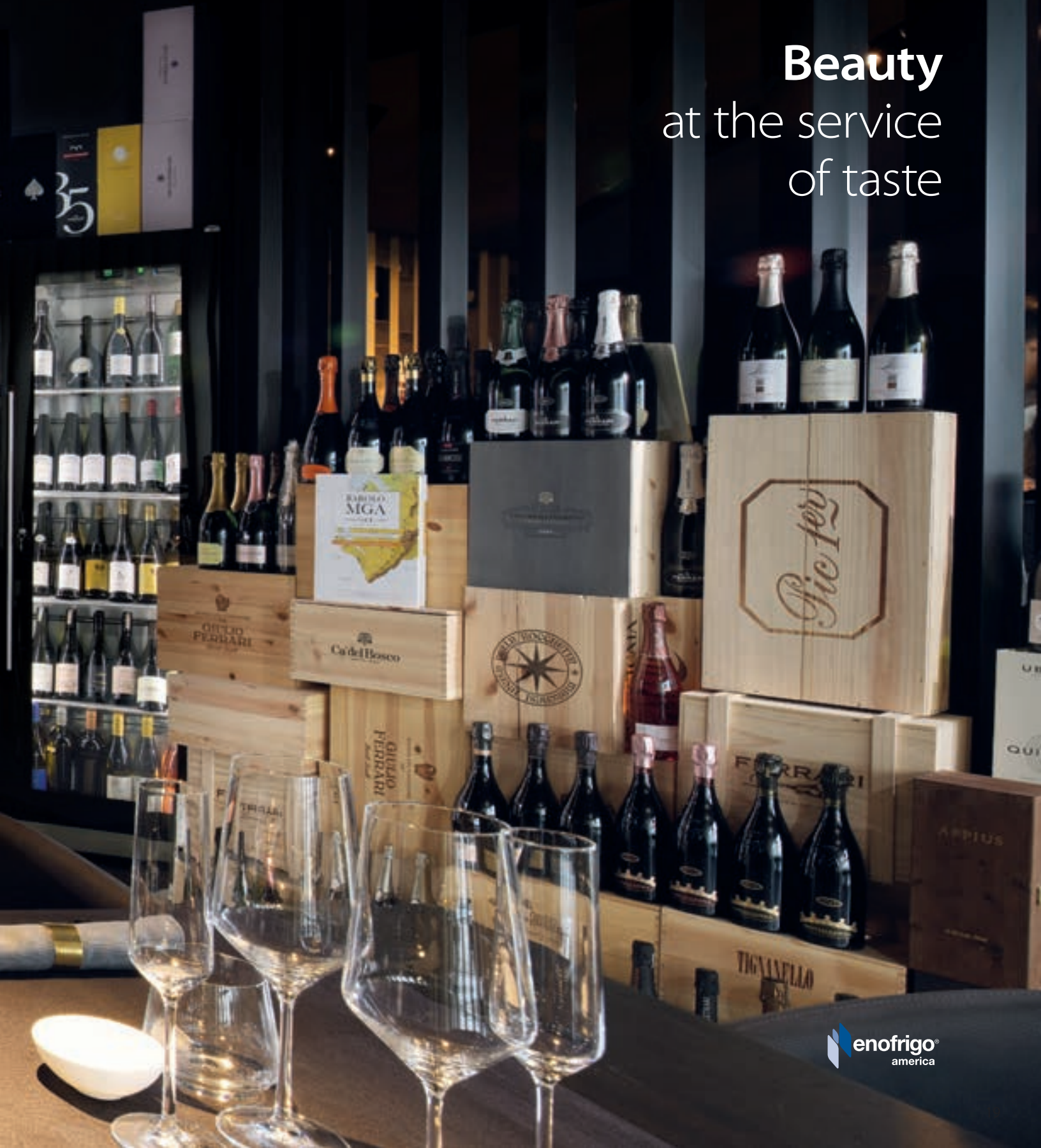

WINE LIBRARY

Beauty at the service of taste

Here is an ideal way to display bottles and ensure exactly the right conditions for preserving and enhancing excellent wines. Clean lines, transparent bottle supports, LED door lighting, mirror-finish interiors, stainless steel handles and the latest laminates combine to embody a modern, elegant design that will add prestige to any high quality wine selection. These modular cabinets can be located in the centre of the room or along the walls depending on the effect you wish to obtain. Interior layouts can be customised to present bottles vertically, reclined or horizontally, on shelves made from stainless steel or perforated plexiglass, on steel tubes or on elegant clear plexiglass cradles. A precision control system optimises the efficiency of the refrigeration system while digital humidity control maintains the ideal conditions for preserving corks and labels.





WINE LIBRARY



ECO FRIENDLY

Energy efficient

With LED lighting, 2 inches thick insulation, a 3/4 inch thick low emissions, double-glazing glass door and a control system which improves the efficiency of the refrigeration equipment, energy consumption is quite low in this unit.



Elegant design

Sleek, clean lines, transparent bottle racks, mirrored internal walls, stainless steel handles, and modern, laminated wood create an elegant and refined frame to showcase wine bottles.



Temperature

The temperature settings in this unit range from 39°F to 68°F, which can be set easily by the operator for each module.

Display



Colour options

The wood laminate body is available in both semi-glossy black and brushed aluminium grey. The unit's door frames are made of anodized aluminium in silver or black. Other colour options are available upon request. (Door frame remains black or silver)

Brushed Aluminium Grey



Semi-Glossy Black

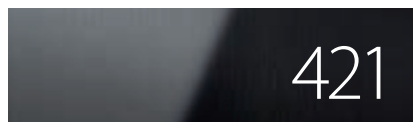

Internal layout

Bottles can be displayed in a variety of positions, according to individual needs and tastes: vertically, with stainless steel shelves (R), on an incline, with stainless steel tubes (A) or horizontally, with both plexiglass supports (C) or stainless steel tubes (T).



Visibility

The Wine Library's wide display area features LED lights along the perimeter of the door as well as mirrored internal walls, creating a striking effect for the ultimate bottle display with a 360° view effect.



Dimmable LED lighting

Being able to adjust your light source means you're able to create the perfect atmosphere in your room, anytime.



Modular size options

Two height options and two or three door models are available. Each unit is equipped with a stand-alone temperature control kit for the refrigerated compartment. Front/rear doors or a closed back are also options, along with internal mirrored laminate.

Two separate packages

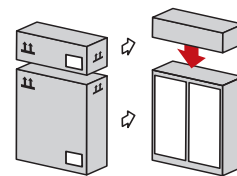

For optimum logistics, the product is supplied in two separate packages, so **installation by Enofrigo America Corp. is recommended.** Ask for quotation.

OPTIONAL - Unfinished*



* Unfinished laminate must be laquered otherwise moisture can attach wood panels. Must be stained by others before put into service. This option may have extended lead time.



WINE LIBRARY

WALL 2P

ISLAND 2P



4V 2P



Shown with optional interior shelving type "RC"

Shown with optional interior shelving type "A"

Shown with optional interior shelving type "TRC"

WINE LIBRARY 2P (2 DOORS)



	MODEL #	(up to)
WINE LIBRARY ISLAND 2P - H	A1WLUI2P266*	420
WINE LIBRARY ISLAND 2P - L	A1WLUI2P226*	336
WINE LIBRARY WALL 2P - H	A1WLUI2P266*	420
WINE LIBRARY WALL 2P - L	A1WLUI2P226*	336
WINE LIBRARY 4V 2P - H	A1WLU4V2P266*	420
WINE LIBRARY 4V 2P - L	A1WLU4V2P226*	336

WINE LIBRARY 3P (3 DOORS)



	MODEL #	(up to)
WINE LIBRARY ISLAND 3P - H	A1WLUI3P266*	630
WINE LIBRARY ISLAND 3P - L	A1WLUI3P226*	504
WINE LIBRARY WALL 3P - H	A1WLUI3P266*	630
WINE LIBRARY WALL 3P - L	A1WLUI3P226*	504
WINE LIBRARY 4V 3P - H	A1WLU4V3P266*	630
WINE LIBRARY 4V 3P - L	A1WLU4V3P226*	504

+39°F
+68°F

A.T. 86°F - R.H. 55%

CLIMATE CLASS 4

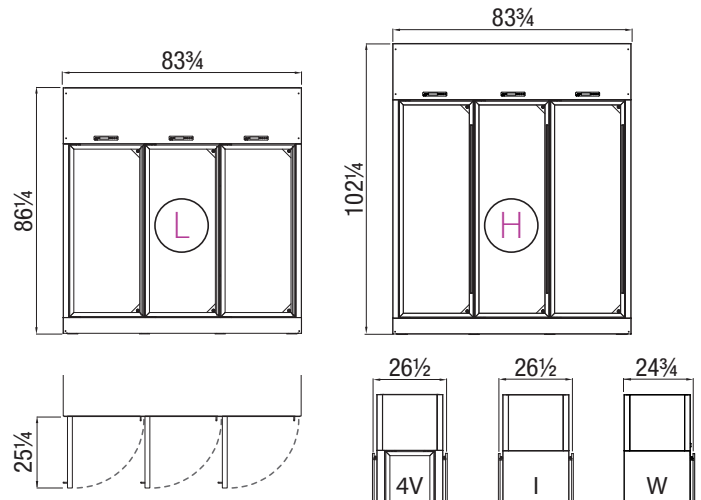
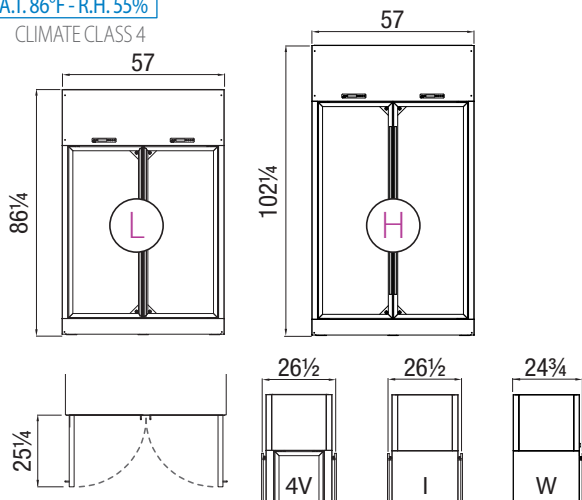

ISLAND 3P H260

4V 3P H220



Shown with optional interior shelving type "R", "C", "R"



Shown with optional interior shelving type "RC", "R", "RC"

OPTIONAL

REMOTE UNIT

Prearranged remotable (WINE LIBRARY) version (without condensing unit) for the single refrigerated compartment

(1P) OPT20001

Prearranged remotable (WINE LIBRARY) version (with condensing unit supplied separately - up to 26 feet on the same level) for the single refrigerated compartment

(1P) OPT20002



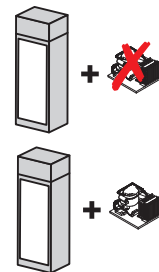







In addition to the listed price

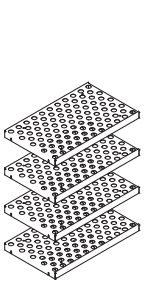
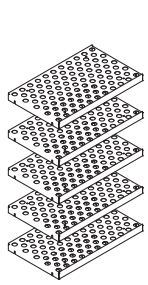
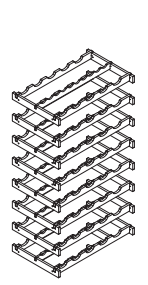
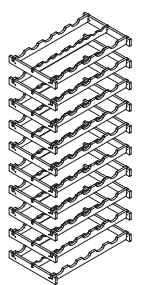
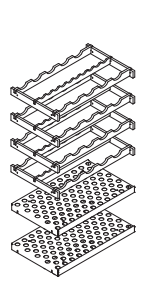
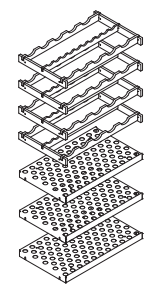
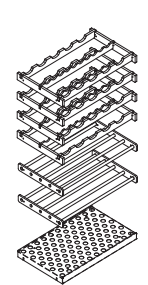
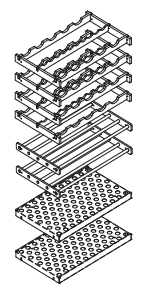

SPECIAL LAMINATED OPTIONAL COLOURS	2P	OPT20009	
SPECIAL LAMINATED OPTIONAL COLOURS	3P	OPT20010	
OPAL LED LIGHT DIFFUSER KIT		OPT20021	
Warm white LED lighting (2700° K)	2P	OPT20022	NOT FOR RETROFIT
Warm white LED lighting (2700° K)	3P	OPT20023	NOT FOR RETROFIT
Warm white LED lighting (3000-3500° K)	2P	OPT20013	NOT FOR RETROFIT
Warm white LED lighting (3000-3500° K)	3P	OPT20014	NOT FOR RETROFIT
Cool white LED lighting (5500-6500° K)	2P	OPT20016	NOT FOR RETROFIT
Cool white LED lighting (5500-6500° K)	3P	OPT20017	NOT FOR RETROFIT
STAINLESS STEEL INTERNAL (single compartment)		OPT20020	
DOUBLE GLAZING PRESSURE EQUALISATION VALVE (> 2,900 ft or 900 m asl)		OPT36005	

Remote connection on site is possible.
(Up to 10 ft. on same level)

WINE LIBRARY INTERNAL LAYOUT

								
	R Stainless Steel Shelves (R)	C Plexiglass Horizontal Supports (C)	RC Stainless Steel Shelves (R) + Plexiglass Horizontal Supports (C)	TRC Stainless Steel Tubes (T) + Stainless Steel Shelves (R) + Plexiglass Horiz. Supports (C)				
	 220 (L) up to 168*	 260 (H) up to 210*	 220 (L) up to 80*	 260 (H) up to 100*	 220 (L) up to 124*	 260 (H) up to 166*	 220 (L) up to 98*	 260 (H) up to 140*
2P	 GK20430006	GK20430004	GK20080015	GK20080014	GK20080020	GK20080021	GK20330013	GK20330014
2P 4V	 GK20430007	GK20430008	GK20080016	GK20080017	GK20080019	GK20080018	GK20330012	GK20330011
3P CENTRAL	 GK20430007	GK20430008	GK20080016	GK20080017	GK20080019	GK20080018	GK20330012	GK20330011
3P LATERAL	 GK20430006	GK20430004	GK20080015	GK20080014	GK20080020	GK20080021	GK20330013	GK20330014
3P 4V CENTRAL	 GK20430007	GK20430008	GK20080016	GK20080017	GK20080019	GK20080018	GK20330012	GK20330011
3P 4V LATERAL	 GK20430007	GK20430008	GK20080016	GK20080017	GK20080019	GK20080018	GK20330012	GK20330011



A

Stainless Steel Sloping Tubes (A)

K

Stainless Steel Tubes (K)

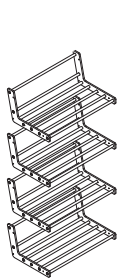

220 (L)
up to 112*

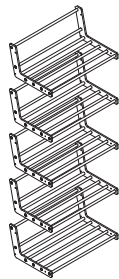

260 (H)
up to 140*

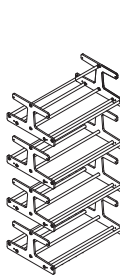

220 (L)
up to 56*

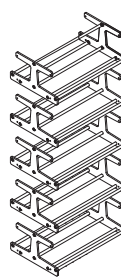

260 (H)
up to 70*

GK20330020

GK20330019

GK20330025

GK20330026

GK20330021

GK20330022

GK20330024

GK20330023

GK20330021

GK20330022

GK20330024

GK20330023

GK20330020

GK20330019

GK20330025

GK20330026

GK20330021

GK20330022

GK20330024

GK20330023

GK20330021

GK20330022

GK20330024

GK20330023

Single shelf capacity

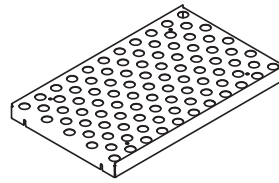

Type "R"
up to 42*

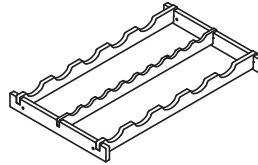

Type "C"
up to 10*

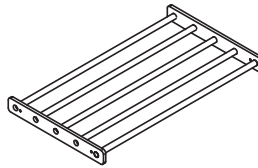

Type "T"
up to 8*

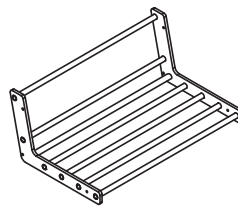

Type "A"
up to 28*

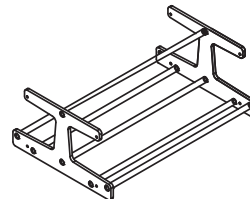

Type "K"
up to 14*

* Maximum storage capacity, based on Bordeaux bottles (shape and size)

Two separate packages

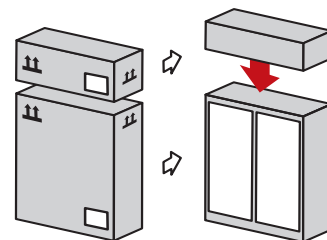

For optimum logistics, the product is supplied in two separate packages, so **installation by Enofrigo America Corp. is recommended.** Ask for quotation.



Enofrigo America Corp.
3705 William Richardson Drive
South Bend, IN 46628 U.S.A.
Phone: (574) 243 3672
info@enofrigoamerica.com

www.enofrigoamerica.com



Any reproduction of this catalogue may not correspond exactly to the commercialised versions since they are subject to laws and regulations in force in different countries. ENOFRIGO Spa claims the right to introduce changes in manufacturing process and units equipment without prior notice. Colour tones are just samples and may not correspond to the real tone of the unit.

